

Revision Notes			
R1 - NOTES UPDATED TO INCLUDE SPARE PART DETAILS.			
APA: TCG40	Drawn: RBATES	Checked: G. PLITH	Approved: G. PLITH
			Date: 07/04/14
R2 - SCREW HOLES UPDATED ON HOUSING AS PER ECR CR-A292.			
APA: YZHANG	Drawn: RBATES	Checked: A. FEDERIGHI	Approved: G. PLITH
			Date: 10/07/14

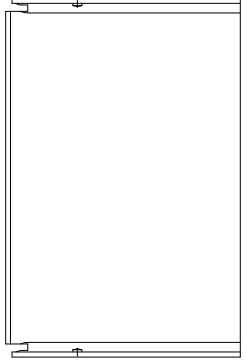
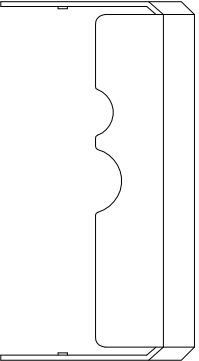
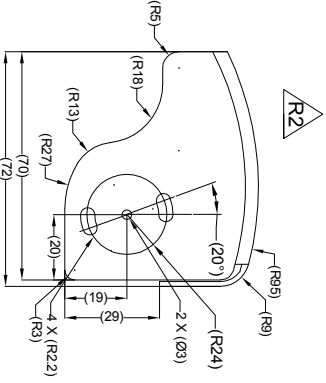
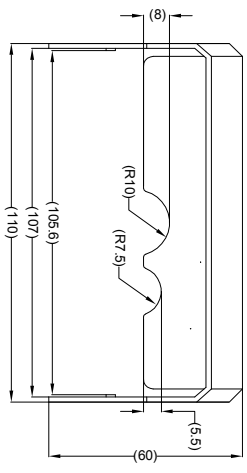
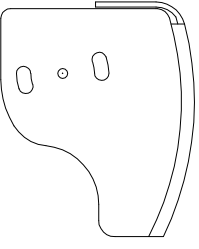
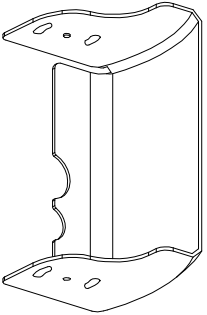
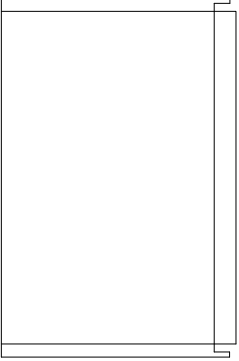

- NOTES:
1. FINISH: BLACK.
 2. MATERIAL: STEEL 1.5T
 3. WHEN SUPPLIED AS A SPARE PART ITEM TO BE SUPPLIED IN A PRESS SEAL BAG.
 4. WHEN SUPPLIED AS A SPARE PART FOR GIFTBOX LABEL REFER TO LATEST REVISION OF DRAWING BE-001049-XX-10.

PROPRIETARY NOTICE
 THIS DESIGN AND TECHNICAL INFORMATION APPEARING ON THIS DRAWING IS THE PROPERTY OF BRIGADE ELECTRONICS, AND IS DISCLOSED IN CONFIDENCE. IT IS NOT TO BE COPIED, REPRODUCED, REVEALED TO OR EXPLOITED BY OTHERS, EITHER IN WHOLE OR IN PART WITHOUT THE EXPRESS WRITTEN CONSENT OF BRIGADE ELECTRONICS.

BRIGADE
 www.brigade-electronics.com

 Angle of Projection Third Angle	Assembly Pl Approval		Approved by		Checked by		Drawn by	
	DKERAL		JNEWMAN		MBUTLER			
Status RELEASED	Units mm	Scale N/A	Released 09/02/11	Assembly Ref CW635 SUNSHIELD	VBV-71XC SS			
Part No 3657				BE-001431-02-11				